

Ophthalmologische Einweginstrumente

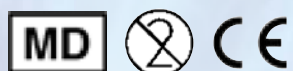

einwegmed®



www.scilo.de

Version 09 - 10/2022

Hygiene & Sauberkeit

- Durch RDG (Reinigung-Desinfektion-Gerät) gesäuberte Instrumente ohne jegliche Verunreinigungen,
- ETO-Gas „Ethylenoxid“ sterilisiert,
- alle Produktionszyklen nachprüfbar dokumentiert,
- zertifiziert DIN EN ISO 13485:2016 und Directive 93/42/EWG gem. Anhang V (0044).

Qualität

- Chargenübergreifend von gleichem Maß und Qualität,
- immer ein neues Instrument,
- gefertigt aus medizinischem Einweg-Instrumentenstahl,
- mit matter, satiniertes Oberfläche,
- abgerundete Kanten und Ecken.

Lieferung

- zuverlässige Erreichbarkeit und Kommunikation,
- schnelle und pünktliche Lieferung durch umfangreiche Lagerhaltung.

INFORMATION zum Katalog

Q = Premium-Qualität

Einen Teil der ophthalmologischen Metall-Einweginstrumente bieten wir in zwei verschiedenen Qualitäten an. Die Standard- und Premiumqualität. Die Bestellnummern/Artikelnummern unterscheiden sich durch ein „-Q“ am Ende der Nummer und die rote Schriftfarbe. Artikelnummern mit -Q gehören zur Premium-Qualität.

Unsere Einweginstrumente bieten wir an:

STERIL in 10er oder 20er Spender-Entnahmeboxen
oder

UNSTERIL als BULK-Ware zur Weiterverarbeitung durch Verarbeiter/Setpacker
für medizinische Einweg-Set's/Behandlungseinheiten.

Adson-Pinzette	Seite	18
Arterienklemme	Seite	61
Augenmarker	Seite	37-39
Augenschutzschale	Seite	40-41
Chalazionklemme	Seite	60
Chalazionlöffel	Seite	58-59
Claw-Phaco-Chopper	Seite	43
Chopper	Seite	43-45
Draht-Lidsperrerr	Seite	27-32
Faltzängchen	Seite	19
Federscheren/Scheren	Seite	19-26
Fixierring	Seite	36
Flap Separator	Seite	47
Fremdkörper- & Cilienpinzette	Seite	15-16
Fremdköpernadeln	Seite	35
Hagelkornklemme	Seite	60
Hornhaut Epithel	Seite	51
Hornhautheber (Spatel)	Seite	52-53
Inzisions-Instrument	Seite	39
Irishäckchen	Seite	44
Justierbare Lidsperrerr	Seite	27-28
Kernspalter	Seite	42
Kinderlidsperrerr	Seite	29
Klemmen aus Kunststoff (Hilfsmittel)	Seite	62-63
Lasek Trichter	Seite	54
Lens Dialer	Seite	49
Lidhaken	Seite	32-34
Lidplatte	Seite	34
Lidsperrerr	Seite	27-32
Linsenkernrotierer	Seite	45
Manipulatoren	Seite	42-53
Mikropinzetten	Seite	4-18
Nadelhalter	Seite	23
Nukleus-/Kapselpolierer	Seite	42
Phaco-Chopper	Seite	43
Phako Spatel	Seite	53
Pinzetten-Capsulorhexis	Seite	7-9
Pinzetten-Cilien- & Fremkörper	Seite	15-16
Pinzetten-Colibri	Seite	4-5
Pinzetten-Iris	Seite	5
Pinzetten-Hoskins	Seite	6
Pinzetten-Linsenwender-Faltpinzette	Seite	12
Scharfer Löffel	Seite	58-59
Scheren	Seite	19-22, 24-26
Scheren, selbstfendernd	Seite	19-22
Schielhaken	Seite	48
Scleral Depressor	Seite	55
Sehnenscheren	Seite	25
Spatel	Seite	52-53
Strabismus Hook	Seite	44
Tränenwegsonde	Seite	56-57
Verstellbare Lidsperrerr	Seite	27-28
Wund- & Hauthäckchen	Seite	49
Zirkel Castroviejo	Seite	38

Mikropinzette chirurgisch

1 into 2 Zähne (chirurgisch),
mit 5 mm Halteplatte
Ausführung: **lang**

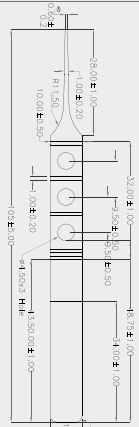

Ref.-Nr.: **AO-201**

Standard-Variante
Länge: 100 mm



Mikropinzette chirurgisch

1 into 2 Zähne (chirurgisch),
mit 5 mm Halteplatte
Ausführung: **lang**

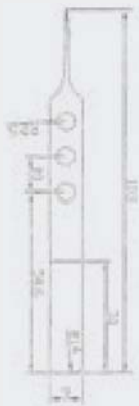

Ref.-Nr.: **AO-201-Q**

Premium-Variante
Länge: 100 mm



Mikropinzette CAPSULORHEXIS

Spitze 45° gewinkelt
Spitze bis Winklung 14 mm
Ausführung: **kurz**

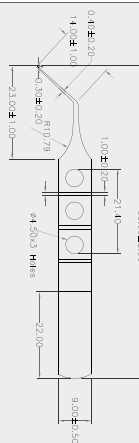

Ref.-Nr.: **AO-205**

Standard-Variante
Länge: 85 mm



Mikropinzette CAPSULORHEXIS

Spitze 45° gewinkelt
Spitze bis Winklung 14 mm
Ausführung: **kurz**

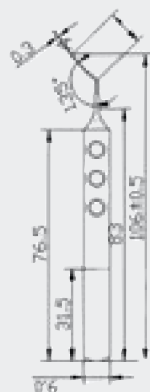

Ref.-Nr.: **AO-205-Q**

Premium-Variante
Länge: 85 mm



Mikropinzette CAPSULORHEXIS

Spitze 45° gebogen
Spitze bis Winklung 14 mm
Ausführung: **lang**

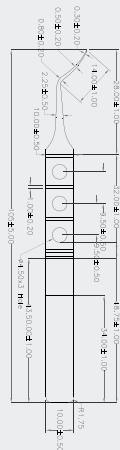

Ref.-Nr.: **AO-192** Standard-Variante
Länge: 105 mm



Mikropinzette CAPSULORHEXIS

Spitze 45° gebogen
Spitze bis Winklung 14 mm
Ausführung: **lang**



Ref.-Nr.: **AO-192-Q** Premium-Variante
Länge: 105 mm



Mikropinzette CAPSULORHEXIS

Spitze 45° gewinkelt
Spitze bis Winklung 14 mm
Ausführung: **lang**

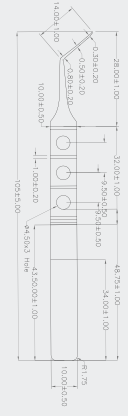

Ref.-Nr.: **AO-194** Standard-Variante
Länge: 105 mm



Mikropinzette CAPSULORHEXIS

Spitze 45° gewinkelt
Spitze bis Winklung 14 mm
Ausführung: **lang**

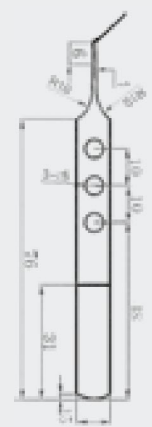

Ref.-Nr.: **AO-194-Q** Premium-Variante
Länge: 105 mm



Mikropinzette CAPSULORHEXIS

Spitze 45° gebogen
Winklung bis Spitze 12 mm
Ausführung: **runder Griff**

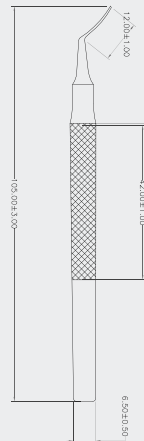

Ref.-Nr.: **AO-328** Standard-Variante
Länge: 105 mm



Mikropinzette CAPSULORHEXIS

Spitze 45° gebogen
Winklung bis Spitze 12 mm
Ausführung: **runder Griff**



Ref.-Nr.: **AO-328-Q** Premium-Variante
Länge: 105 mm



Federpinzette CAPSULORHEXIS x-Action

45° gewinkelt, gebogen
Winklung bis Spitze 12 mm
Ausführung: **x-Action = gekreuzte Spitze**



Ref.-Nr.: **AO-326** Standard-Variante
Länge: 105 mm



Federpinzette CAPSULORHEXIS x-Action

45° gewinkelt, gebogen
Winklung bis Spitze 12 mm
Ausführung: **x-Action = gekreuzte Spitze**



Ref.-Nr.: **AO-326-Q** Premium-Variante
Länge: 105 mm



Mindestbestimmungen - unsteril / steril - auf Anfrage

Mikro-Nahtpinzette ST. MARTIN

1 into 2 Zähne (chirurgisch)
mit 5,0 mm Halteplatte
Ausführung: **gerade, kurz**

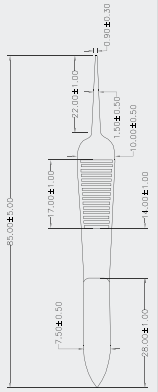

Ref.-Nr: **AO-202** Standard-Variante
Länge: 85 mm



Mikro-Nahtpinzette ST. MARTIN

1 into 2 Zähne (chirurgisch)
mit 5,0 mm Halteplatte
Ausführung: **gerade, kurz**

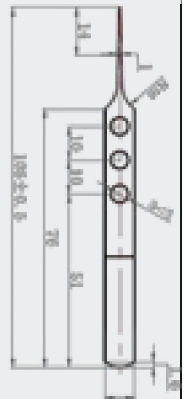
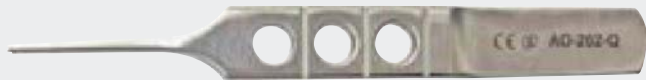
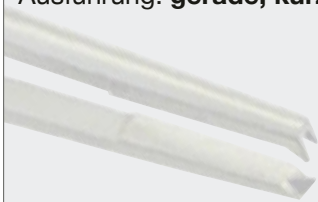

Ref.-Nr: **AO-202-Q** Premium-Variante
Länge: 85 mm



Mikro-Faltpinzette

Linsen-Wender, 45° gewinkelt
mit Halteplatte für 5-6 mm IOL

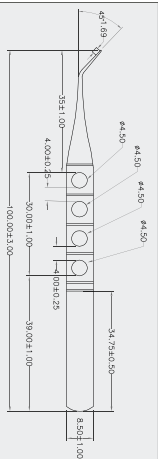

Ref.-Nr: **AO-248** Standard-Variante
Länge: 100 mm



Mikro-Faltpinzette

Linsen-Wender, 45° gewinkelt
mit Halteplatte für 5-6 mm IOL

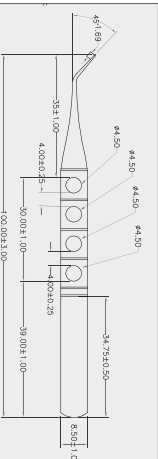

Ref.-Nr: **AO-248-Q** Premium-Variante
Länge: 100 mm



Mikro-Fadenpinzette KELMANN'S

45° gewinkelt
mit Halteplatte
Ausführung: **kurz**

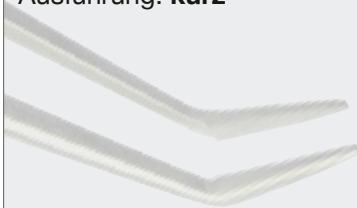

Ref.-Nr.: **AO-273** Standard-Variante
Länge: 85 mm

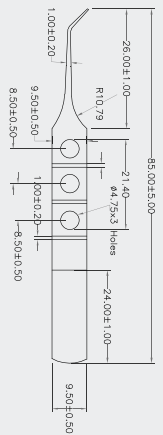

Mikro-Fadenpinzette KELMANN'S

45° gewinkelt
mit Halteplatte
Ausführung: **kurz**

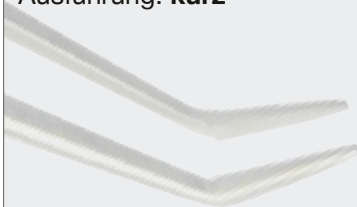

Ref.-Nr.: **AO-273-Q** Premium-Variante
Länge: 85 mm

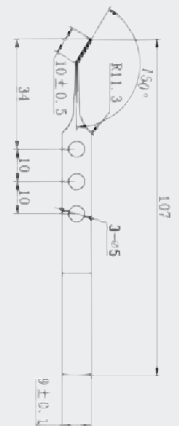
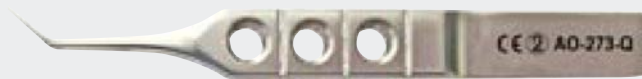

Mikro-Fadenpinzette MC'PHERSON

45° gewinkelt
mit 4,5 mm Halteplatte
Ausführung: **lang**

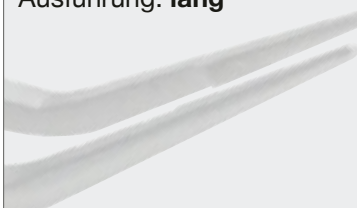

Ref.-Nr.: **AO-203** Standard-Variante
Länge: 100 mm

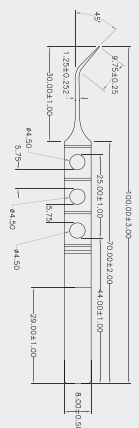

Mikro-Fadenpinzette MC'PHERSON

45° gewinkelt
mit 4,5 mm Halteplatte
Ausführung: **lang**



Ref.-Nr.: **AO-203-Q** Premium-Variante
Länge: 100 mm

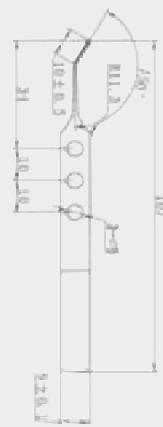

Cilien- & Fremdkörperpinzette SHAAF

Anwendungsbereich spitz
mit gegenüberliegender Nut
Ausführung: **gebogen**

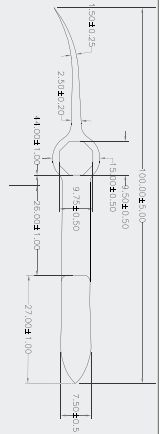

Ref.-Nr.: **AO-207**

Standard-Variante
Länge: 100 mm



Cilien- & Fremdkörperpinzette SHAAF

Anwendungsbereich spitz
mit gegenüberliegender Nut
Ausführung: **gebogen**



Ref.-Nr.: **AO-207-Q**

Premium-Variante
Länge: 95 mm



Cilien- & Fremdkörperpinzette BEER

Anwendungsbereich runde Platte
Ausführung: **gerade**

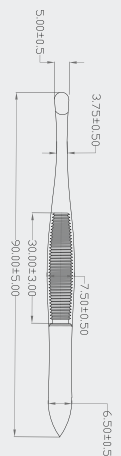

Ref.-Nr.: **AO-219**

Standard-Variante
Länge: 90 mm



Mikro-Cilienpinzette BARRAQUER

glatte Halteplatte
Ausführung: **gewinkelt**

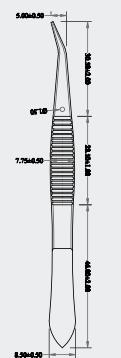

Ref.-Nr.: **AO-223**

Standard-Variante
Länge: 105 mm



Naht- & Bindehautpinzette MOORFIELD

gezahnte Bindungsplattform
Ausführung: **gerade**



Ref.-Nr.: **AO-190** Standard-Variante
Länge: 100 mm



Naht- & Bindehautpinzette MOORFIELD

gezahnte Bindungsplattform
Ausführung: **gerade**



Ref.-Nr.: **AO-190-Q** Premium-Variante
Länge: 110 mm



Fadenpinzette BARRAQUER

mit Halteplatte
Ausführung: **gerade**



Ref.-Nr.: **AO-213** Standard-Variante
Länge: 90 mm



Fadenpinzette BARRAQUER

mit Halteplatte
Ausführung: **gebogen**

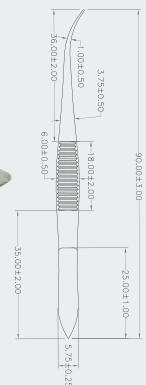

Ref.-Nr.: **AO-213-C** Standard-Variante
Länge: 90 mm



Pinzetten anatomisch

geriffter Anwendungsbereich
mit Führungsstift
Ausführung: **fein, gerade, lang**



Ref.-Nr: **4409-S**
KB-4409-S

mit zusätzlicher Klebebandmarkierung
Standard-Variante
Länge: 105 mm



Pinzetten anatomisch

geriffter Anwendungsbereich
mit Führungsstift
Ausführung: **fein, gebogen, lang**



Ref.-Nr: **4409-C**
KB-4409-C

mit zusätzlicher Klebebandmarkierung
Standard-Variante
Länge: 105 mm

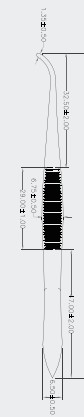

Chirurgische Fasspinzette ADSON

1 into 2 Zähne (chirurgisch)
Ausführung: **fein, gerade, lang**



Ref.-Nr: **4400-SM**
KB-4400-SM

mit zusätzlicher Klebebandmarkierung
Standard-Variante
Länge: 125 mm

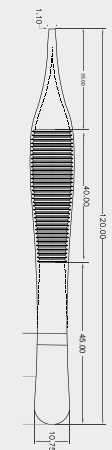

Anatomische Fasspinzette ADSON

mit Riffelung (anatomisch)
Ausführung: **fein, gerade, lang**

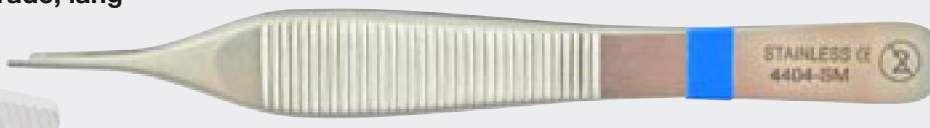

Ref.-Nr: **4404-SM**
KB-4404-SM

mit zusätzlicher Klebebandmarkierung
Standard-Variante
Länge: 125 mm

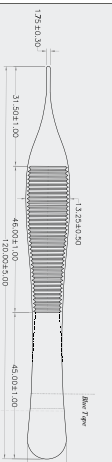

Faltzängchen

gekreuzter Fassbereich
Federinstrument
mit Verriegelung

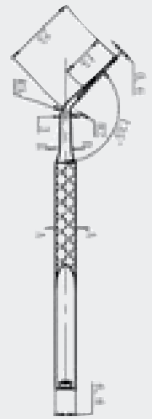
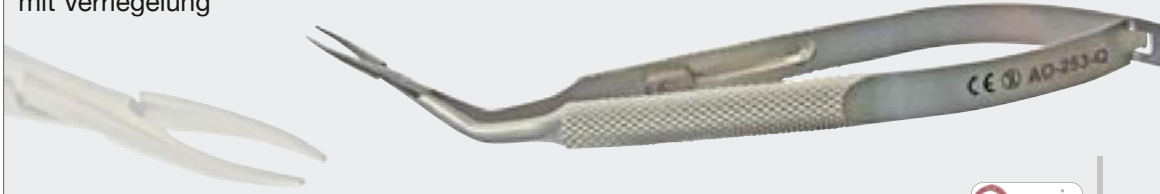

Ref.-Nr: **AO-253-Q** Premium-Variante
Länge: 115 mm

Qserie



Mikro-Hornhautschere KATZIN

Federschere mit Flachgriff
Ausführung: für **LINKS-Händer**

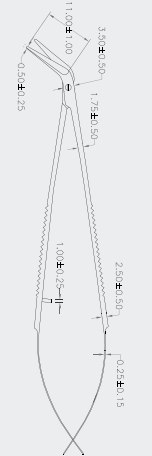
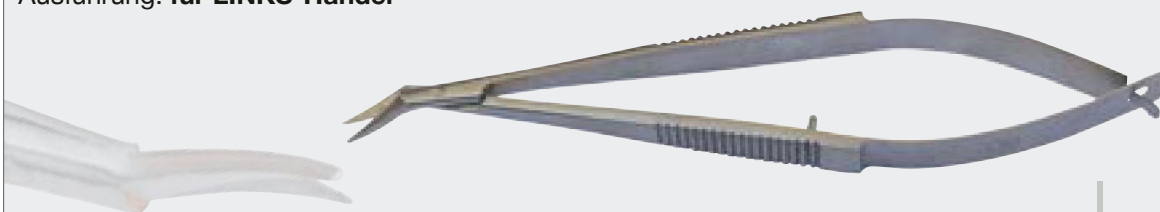

Ref.-Nr: **AO-303-L** Standard-Variante
Länge: 110 mm



Mikro-Hornhautschere KATZIN

Federschere mit Flachgriff
Ausführung: für **RECHTS-Händer**

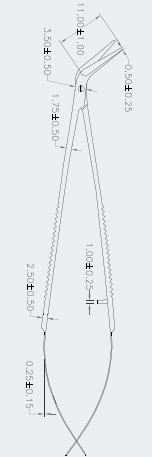
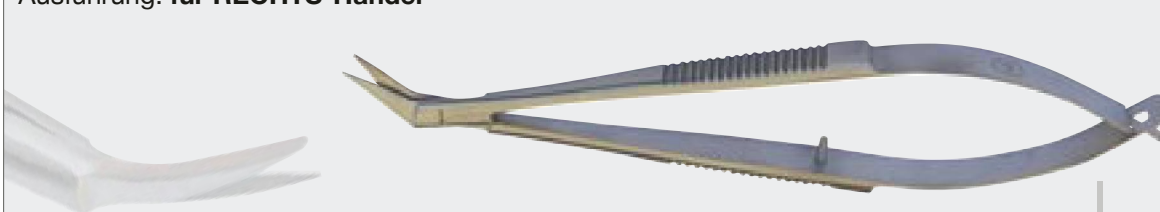

Ref.-Nr: **AO-303-R** Standard-Variante
Länge: 110 mm



Mikro-Hornhautschere CASTROVIEJO

Federschere mit Flachgriff
Ausführung: **Kniegebogen**



Ref.-Nr: **AO-830** Standard-Variante
Länge: 100 mm



Federschere WESTCOTT

Iridektomieschere mit Flachgriff
Ausführung: **gebogen, lang**

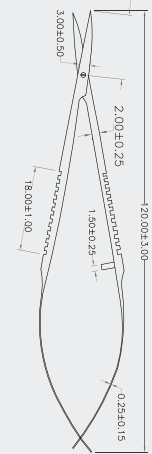

Ref.-Nr.: **AO-301-C** Standard-Variante
Länge: 120 mm



Federschere WESTCOTT

Iridektomieschere mit Flachgriff
Ausführung: **gebogen, lang**

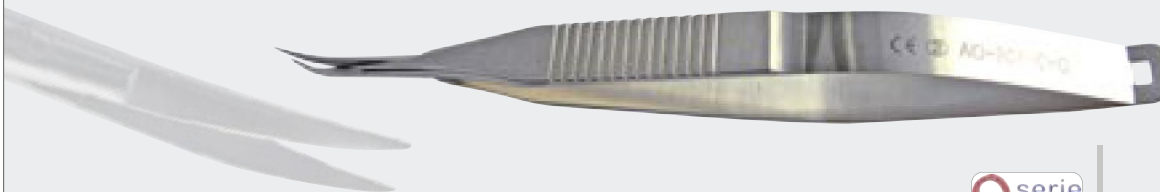

Ref.-Nr.: **AO-301-C-Q** Premium-Variante
Länge: 120 mm



Federschere WESTCOTT

Iridektomieschere mit Flachgriff
Ausführung: **gerade, lang**

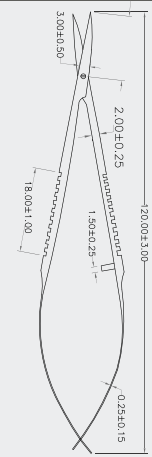

Ref.-Nr.: **AO-301-S** Standard-Variante
Länge: 120 mm



Federschere WESTCOTT

Iridektomieschere mit Flachgriff
Ausführung: **gerade, lang**



Ref.-Nr.: **AO-301-S-Q** Premium-Variante
Länge: 120 mm



Mikro-Nachstarschere VANNAS

Federschere mit Flachgriff
Ausführung: **gebogen, kurz**

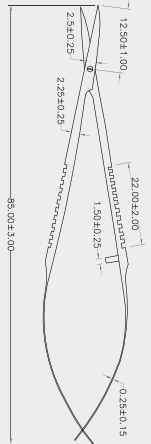

Ref.-Nr.: **AO-304-C**

Standard-Variante
Länge: 85 mm



Mikro-Nachstarschere VANNAS

Federschere mit Flachgriff
Ausführung: **gebogen, kurz**

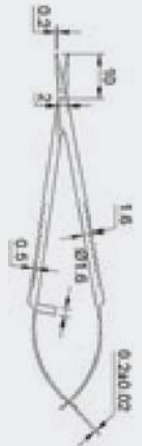

Ref.-Nr.: **AO-304-C-Q**

Premium-Variante
Länge: 85 mm



Mikro-Nachstarschere VANNAS

Federschere mit Flachgriff
Ausführung: **gerade, kurz**

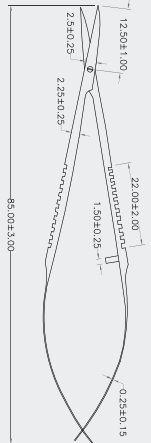

Ref.-Nr.: **AO-304-S**

Standard-Variante
Länge: 85 mm



Mikro-Nachstarschere VANNAS

Federschere mit Flachgriff
Ausführung: **gerade, kurz**

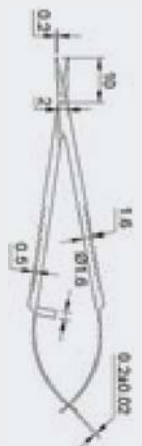

Ref.-Nr.: **AO-304-S-Q**

Premium-Variante
Länge: 85 mm



Mikro-Kapsulotomieschere ONG TYPE

Federschere mit Flachgriff
Spitze nach oben gebogen
Ausführung: **kurz**

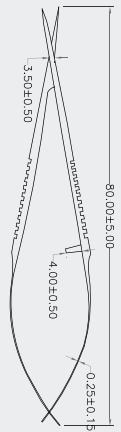

Ref.-Nr.: **AO-580**

Standard-Variante
Länge: 80 mm



Mikro-Kapsulotomieschere ONG TYPE

Federschere mit Flachgriff
Spitze nach oben gebogen
Ausführung: **kurz**

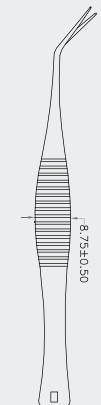

Ref.-Nr.: **AO-580-Q**

Premium-Variante
Länge: 80 mm



Mikro-Iridektomieschere NOYES

Federschere mit Flachgriff
Ausführung: **lang, gebogen**

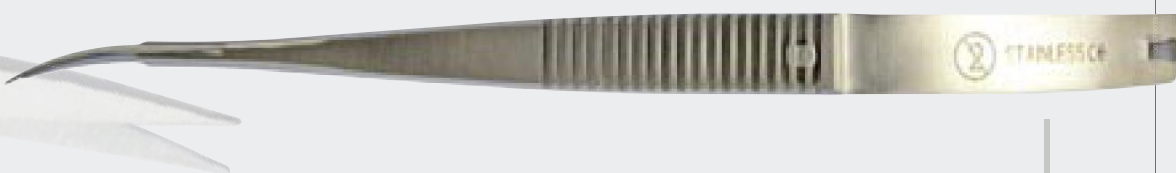
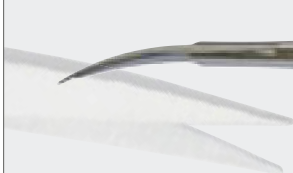

Ref.-Nr.: **AO-302-C**

Standard-Variante
Länge: 160 mm



Mikro-Iridektomieschere NOYES

Federschere mit Flachgriff
Ausführung: **lang, gerade**

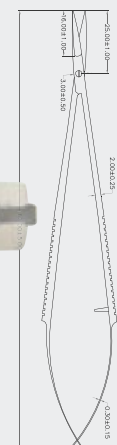

Ref.-Nr.: **AO-302-S**

Standard-Variante
Länge: 160 mm



IRIS-Schere

verschiedene Varianten
Ausführung: **gerade, spitz**

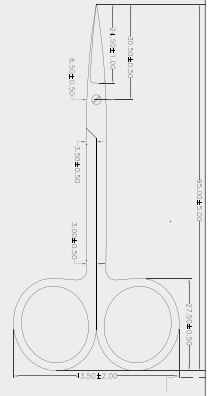

Ref.-Nr.: **71358-C** gebogen
71358-S gerade Standard-Variante
Länge: 95 mm



IRIS-Schere

verschiedene Varianten
Ausführung: **gerade, spitz**

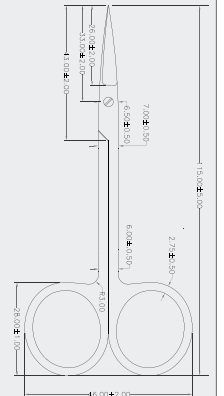

Ref.-Nr.: **71360-C** gebogen
71360-S gerade Standard-Variante
Länge: 115 mm



IRIS-Schere

verschiedene Varianten
Ausführung: **gerade, stumpf**

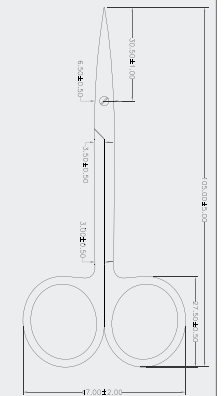
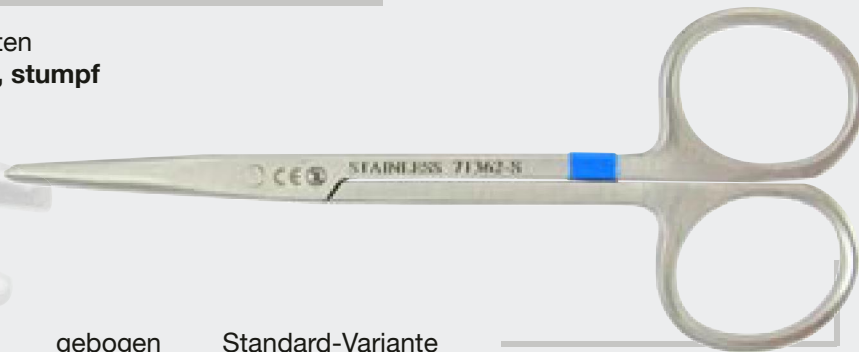

Ref.-Nr.: **71362-C** gebogen
71362-S gerade Standard-Variante
Länge: 115 mm



Universal-Schere mit Kunststoff-Griff

blauer Griff
Ausführung: **gerade, spitz**



Ref.-Nr.: **2255** Standard-Variante
Länge: 100 mm



Sehnenschere STEVENS

verschiedene Varianten
Ausführung: **spitz, kurz**

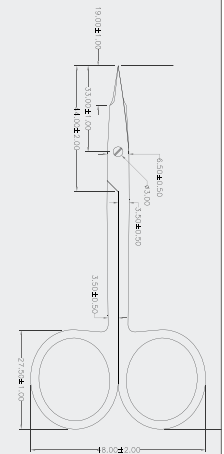

Ref.-Nr.: **AO-307-C** gebogen Standard-Variante
AO-307-S gerade Länge: 115 mm



Sehnenschere STEVENS

verschiedene Varianten
Ausführung: **spitz, mittellang**

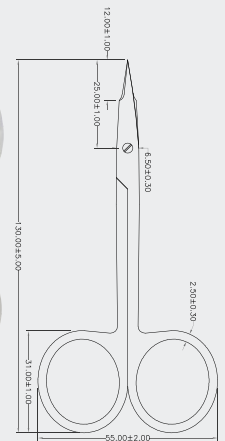

Ref.-Nr.: **AO-308-C** gebogen Standard-Variante
AO-308-S gerade Länge: 130 mm



Sehnenschere STEVENS

verschiedene Varianten
Ausführung: **spitz, lang**

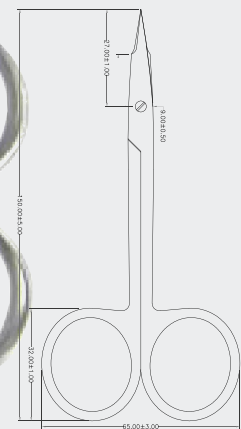
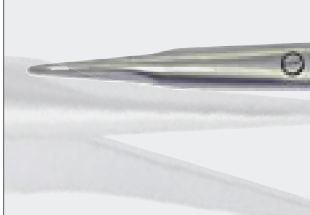

Ref.-Nr.: **AO-306-C** gebogen Standard-Variante
AO-306-S gerade Länge: 150 mm



In unserem Sortiment finden Sie auch hochwertige chirurgische und gynäkologische Einweginstrumente!

Fragen Sie nach unserer Übersicht „Chirurgische Einweginstrumente“.



Lidsperrer LIEBERMANN

justierbar
mattierte Oberfläche
Draht Valven
nasale Biegung

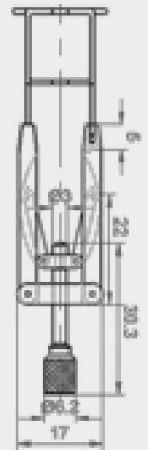

Ref.-Nr: **AO-120-Q** Premium-Variante
Länge: 75 mm

Qserie



Lidsperrer LIEBERMANN

justierbar
mattierte Oberfläche
geschlossene Valven
nasale Biegung

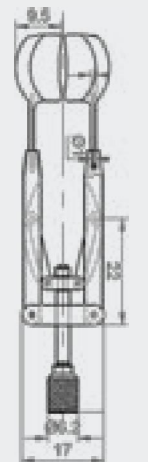

Ref.-Nr: **AO-121-Q** Premium-Variante
Länge: 75 mm

Qserie



Lidsperrer LIEBERMANN mit Absaugung

justierbar
mattierte Oberfläche
geschlossene Valven
nasale Biegung

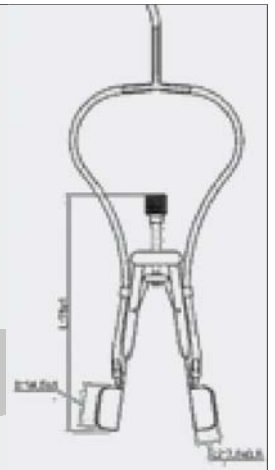
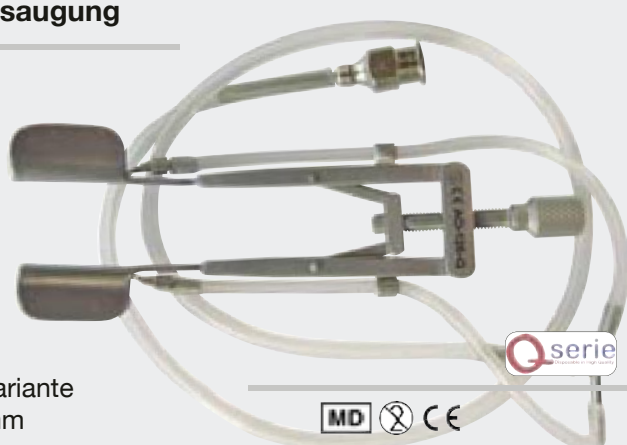

Ref.-Nr: **AO-126-Q** Premium-Variante
Länge: 75 mm

Qserie



Lidsperrer LIEBERMANN mit Absaugung

justierbar
mattierte Oberfläche
Draht Valven
nasale Biegung

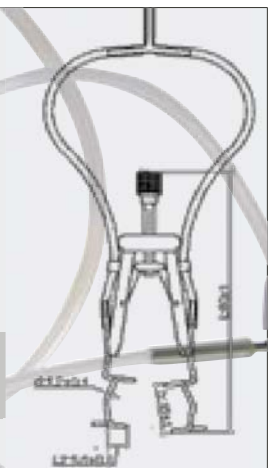
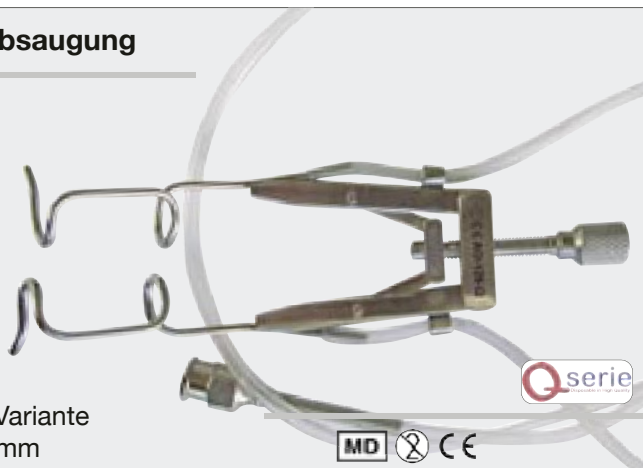

Ref.-Nr: **AO-128-Q** Premium-Variante
Länge: 75 mm

Qserie

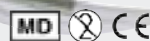

Lidsperrer BANGERTER TEMPORAL

justierbar, geöffnet
mit Drahtvalven 15 mm
mattierte Oberfläche

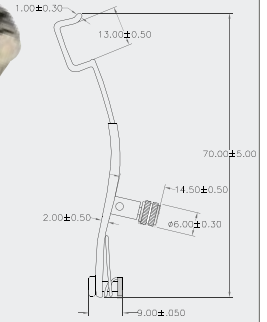
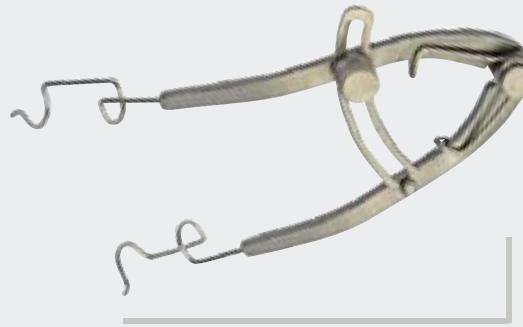

Ref.-Nr.: **AO-122**

Standard-Variante
Länge: 70 mm



Lidsperrer WEISS, gefenstert

justierbar,
Valven gefenstert
mattierte Oberfläche

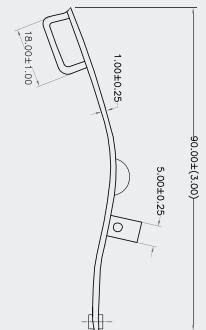

Ref.-Nr.: **AO-123**

Standard-Variante
Länge: 90 mm



Lidsperrer COOK, geschlossen

justierbar,
Valven geschlossen
mattierte Oberfläche

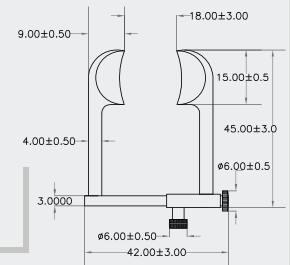

Ref.-Nr.: **AO-124**

Standard-Variante
Länge: 50 mm



Maßstab:

1 : 1

Die Bilder dieser Produktübersicht sind im Maßstab **100%** der Originalgröße dargestellt.

Somit ist auch das Verhältnis von den Instrumenten zueinander im richtigen Verhältnis.

Lidsperrer für Kinder

Lidsperrer Kleinkinder und Neugeborene

selbstfedernd
Valven geschlossen
mattierte Oberfläche



Ref.-Nr.: **AO-514-Q** Paediatric, Valven 6 mm
Ref.-Nr.: **AO-515-Q** Neonate, Valven 4 mm
Premium-Variante



Lidsperrer für Kinder

Draht mit geschlossenen Valven
poliert, glänzend
nasale Biegung

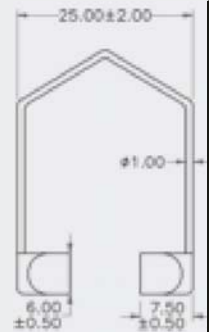

Ref.-Nr.: **AO-101-C** 25x34 mm



Lidsperrer für Kinder

Drahtlidsperrer ohne Steg
geöffnet
nasale Biegung

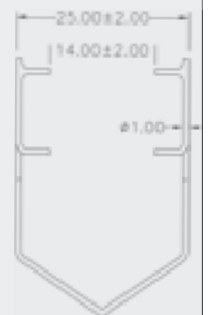
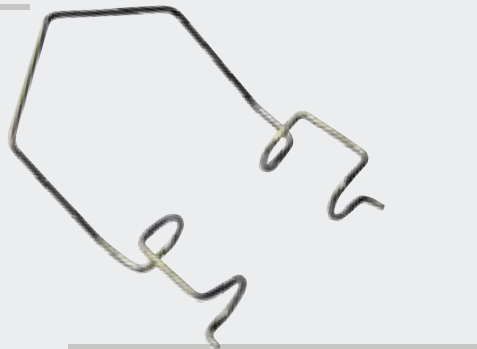

Ref.-Nr.: **AO-100-C** 25x34 mm



Lidsperrer für Kinder

Drahtlidsperrer
gefenstert
nasale Biegung



Ref.-Nr.: **AO-100-CB** 21x34 mm



Lidsperrer BARRAQUER

Draht mit geschlossenen Kunststoff-Valven
transparent, nasale Biegung



Ref.-Nr.: **AO-102-T** 29x42 mm

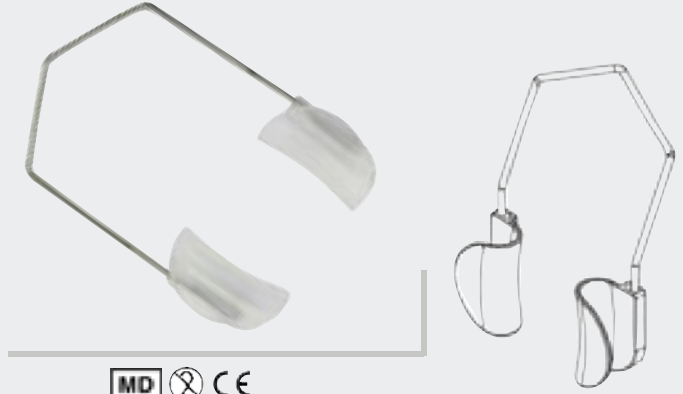

MD CE

Lidsperrer BARRAQUER

Draht mit geschlossenen Valven
poliert, glänzend
nasale Biegung



Ref.-Nr.: **AO-101** 29x42 mm



MD CE

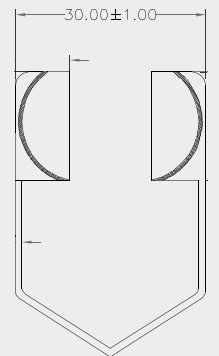

Lidsperrer BARRAQUER

Draht mit geschlossenen Valven
mattierte Oberfläche
nasale Biegung



Ref.-Nr.: **AO-101-M** 29x42 mm

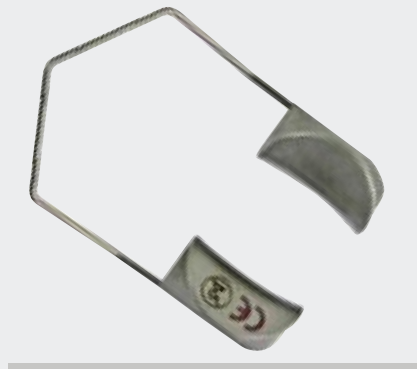

MD CE

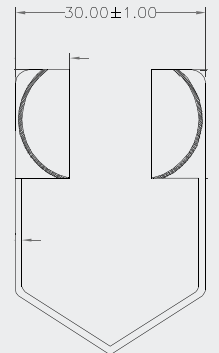

Lidsperrer BARRAQUER

Draht mit geschlossenen Valven
mattierte Oberfläche
nasale Biegung
Draht in die Valven eingelötet



Ref.-Nr.: **AO-101-M-Q** 29x42 mm

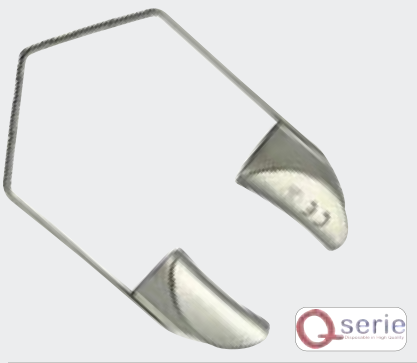

MD CE

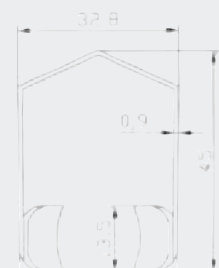

Lidsperrer BARRAQUER

Drahtlidsperrer gefenstert,
mit Steg, nasale Biegung

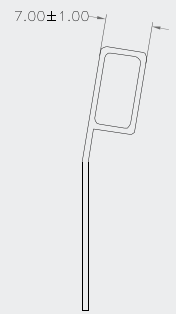
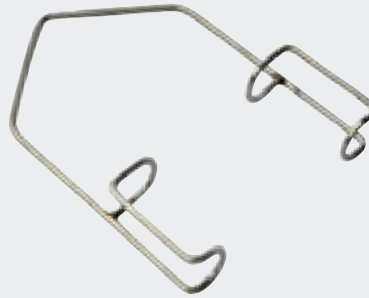

Ref.-Nr.: **AO-100** 29x42 mm



Lidsperrer KRATZ-BARRAQUER

Drahtlidsperrer geöffnet,
ohne Steg, nasale Biegung

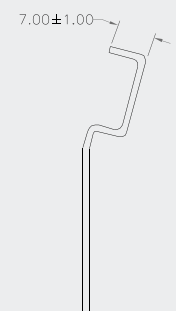
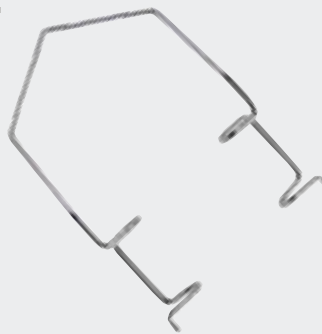

Ref.-Nr.: **AO-100-B** 29x42 mm



Lidsperrer BARRAQUER

Drahtlidsperrer gefenstert,
mit Steg, gerader Halm

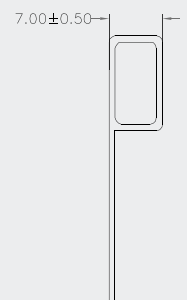
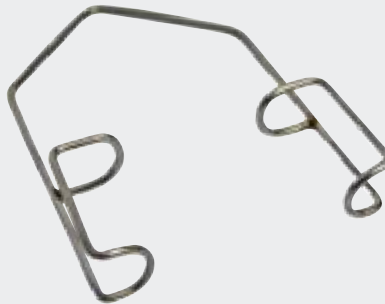

Ref.-Nr.: **AO-100-GH** 29x42 mm

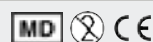

Lidsperrer TEMPORAL

Drahtlidsperrer geöffnet,
ohne Steg, 15 mm Valven
nasale Biegung

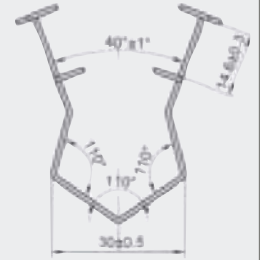

Ref.-Nr.: **AO-106-Q** Premium-Variante



Lidsperrer KRATZ

Drahtlidsperrer mit Steg
nasale Biegung

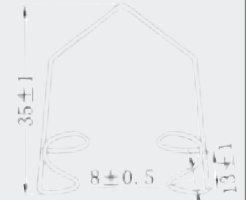
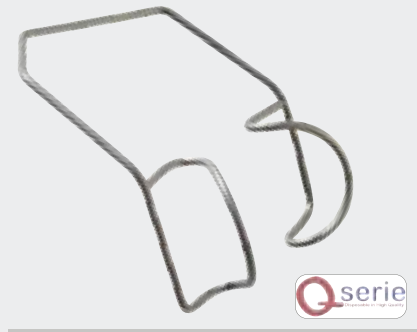

Ref.-Nr.: **AO-107-Q** Premium-Variante



Lidhalter DESMARRES

Breite der Valve 10 mm



Ref.-Nr.: **AO-116-10-Q** Premium-Variante
Länge: 145 mm



Lidhalter DESMARRES schmal

Breite der Valve 10 mm

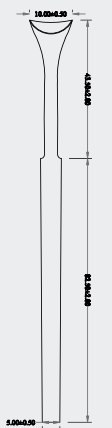

Ref.-Nr.: **AO-116-10** Standard-Variante
Länge: 140 mm



Lidhalter DESMARRES mittel

Breite der Valve 14 mm



Ref.-Nr.: **AO-116-14** Standard-Variante
Länge: 140 mm



Lidhalter DESMARRES breit

Breite der Valve 18 mm



Ref.-Nr.: **AO-116-18-Q** Premium-Variante
Länge: 145 mm



Lidhalter DESMARRES breit

Breite der Valve 18 mm



Ref.-Nr.: **AO-116-18** Standard-Variante
Länge: 140 mm



Lidhaken JAFFE schmal

9 mm Valve
Ausführung: für Kinder, schmal

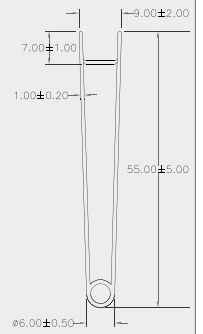

Ref.-Nr.: **AO-114-Q** Premium-Variante
Länge: 55 mm



Lidhaken JAFFE breit

14 mm Valven
Ausführung: breit

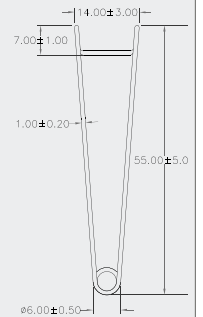
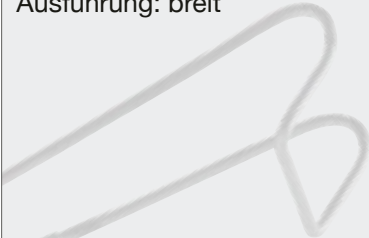

Ref.-Nr.: **AO-112-Q** Premium-Variante
Länge: 55 mm



Lidplatte JAEGER



Ref.-Nr.: **AO-416** Standard-Variante
Länge: 94 mm



Fremdkörpernadel

gebogen
Ausführung: sehr spitz



Ref.-Nr.: **AO-352-C**

Standard-Variante
Länge: 145 mm

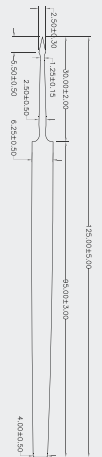

Fremdkörpernadel

gerade
Ausführung: sehr spitz



Ref.-Nr.: **AO-352-S**

Standard-Variante
Länge: 145 mm

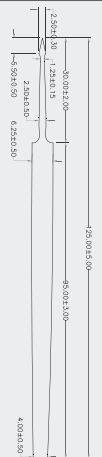

Fremdkörper-Hohlmeißel

2in1 Kombiinstrument
Hohlmeißel und Fremdkörpernadel gebogen



Ref.-Nr.: **AO-354**

Standard-Variante
Länge: 160 mm

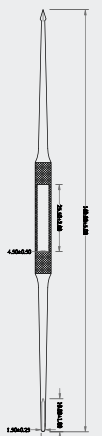

Fixierring THORNTON

mit Schwenkkopf
Ø 13 mm/11 mm Innenring
runder Griff



Ref.-Nr.: **AO-612** Standard-Variante
Länge: 130 mm

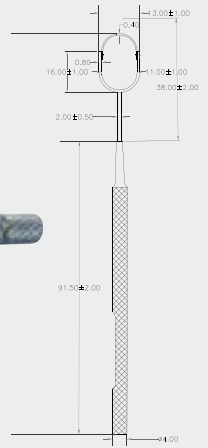

Fixierring THORNTON

mit Schwenkkopf
Ø 13 mm/11 mm Innenring
runder Griff



Ref.-Nr.: **AO-612-Q** Premium-Variante
Länge: 130 mm



Fixierring THORNTON

mit Schwenkkopf
Ø 16 mm/14 mm Innenring
runder Griff



Ref.-Nr.: **AO-613** Standard-Variante
Länge: 130 mm

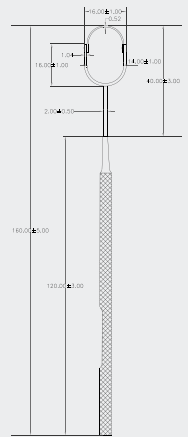

Fixierring THORNTON

mit Schwenkkopf
Ø 16 mm/14 mm Innenring
runder Griff



Ref.-Nr.: **AO-613-Q** Premium-Variante
Länge: 130 mm



Augenmarker SMALL

runder Griff
3,5 + 4,0 mm
Kunststoff Polyamid, blau

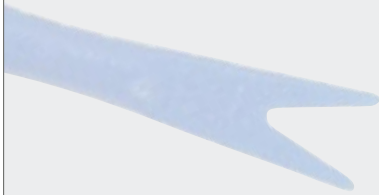

Ref.-Nr: **AO-402** Kunststoff
Länge: 100 mm

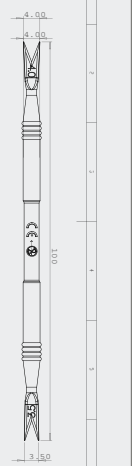

Augenmarker MEDIUM

runder Griff
3,5 + 4,0 mm
Kunststoff Polyamid, blau



Ref.-Nr: **AO-404** Kunststoff
Länge: 90 mm

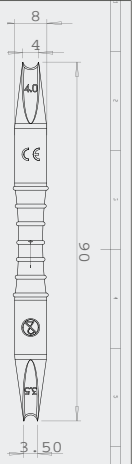

Augenmarker STANDARD

flacher Griff
3,5 + 4,0 mm
Kunststoff Polyamid, blau



Ref.-Nr: **AO-400-B** Kunststoff
Länge: 80 mm

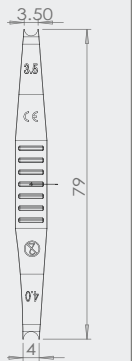

Augen FLACH

sehr flacher Griff
3,5 + 4,0 mm
Metall



Ref.-Nr: **AO-410** Standard-Variante
Länge: 70 mm



Augenmarker BRAUNSTEIN

flach, verjüngende Spitze
3,5 + 4,0 mm
Metall

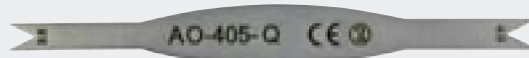

Ref.-Nr.: **AO-405-Q** Premium-Variante
Länge: 70 mm



Augenmarker BRAUNSTEIN

flach
3,5 + 4,0 mm
Metall

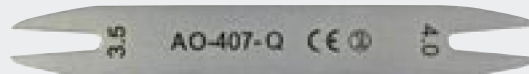

Ref.-Nr.: **AO-407-Q** Premium-Variante
Länge: 70 mm



Zirkel CASTROVIEJO

justierbarer Augenmarker
Scala bis 20 mm
in 0,5 mm Abständen

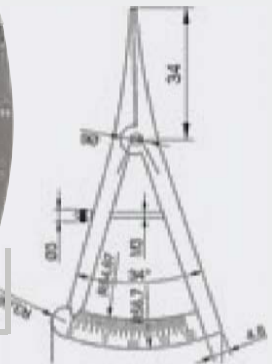

Ref.-Nr.: **AO-406-Q** Premium-Qualität
Länge: 85 mm



Inzisions-Instrument

3,5 + 4,0 mm
 runder Griff
 Fixations-Platte mit länglicher Nut

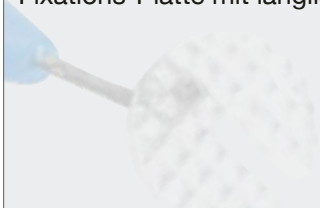

Ref.-Nr: **AO-500** Kunststoff, blau
 Länge: 70 mm

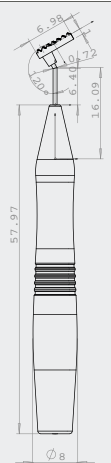

Inzisions-Instrument

3,5 + 4,0 mm
 runder Griff
 Fixations-Platte mit länglicher
 Nut und runder Aussparung



Ref.-Nr: **AO-502** Kunststoff, blau
 Länge: 70 mm

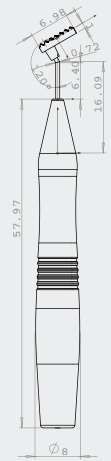

einwegmed[®]

<http://www.einwegmed-shop.de>

Unser Webshop für
 Ärzte und Anwender.

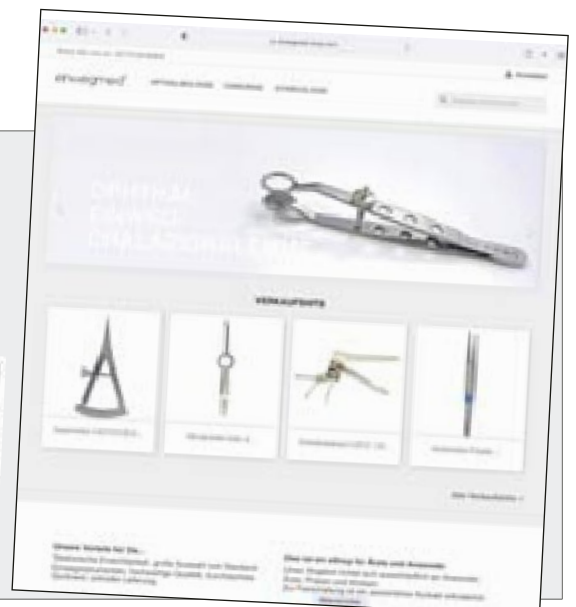

Augenschutzschale 9-loch

Kunststoff, transparent
9-Loch
verstärkter Rand

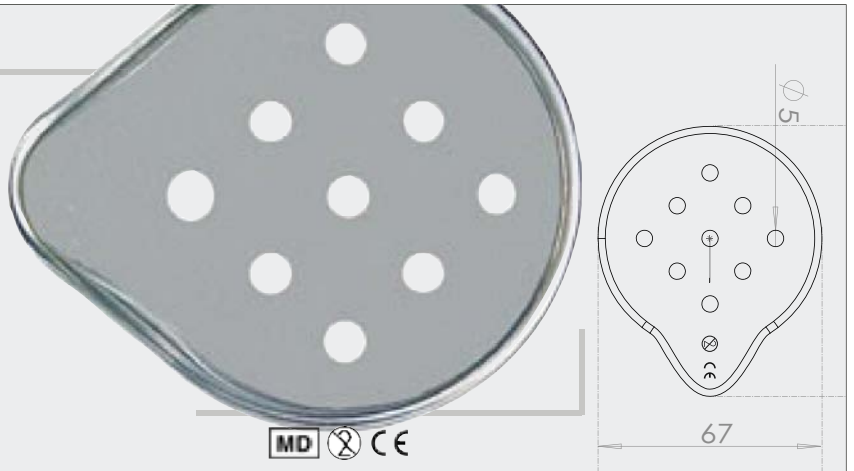

Ref.-Nr.: **AO-600** 80x65 mm



Augenschutzschale segmentiert

Kunststoff, weiß
verstärkter Rand

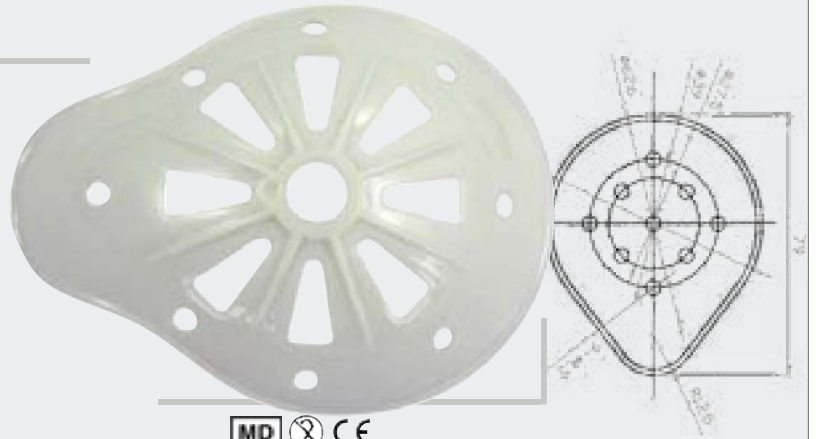

Ref.-Nr.: **AO-605** 76x57 mm



Augenschutzschale

Kunststoff, transparent/milchig
flexibel

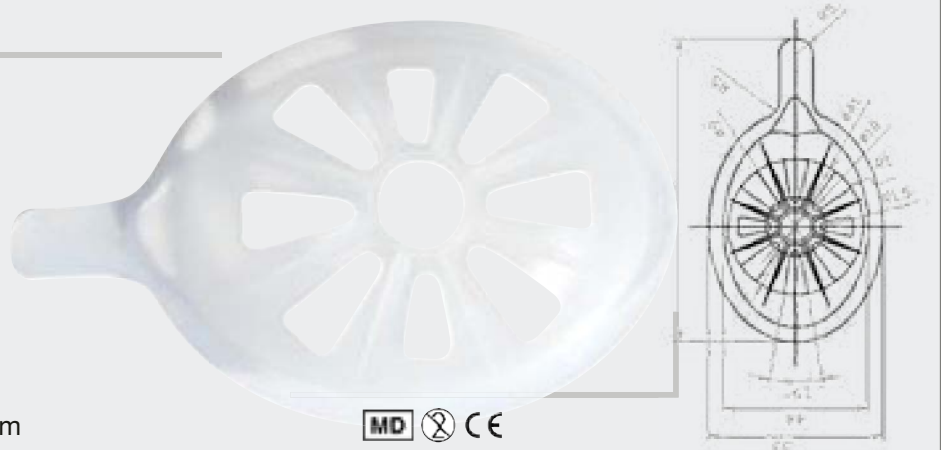

Ref.-Nr.: **AO-604-T** 92x54 mm

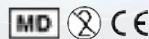

Augenschutzschale Softgrip

Kunststoff-Inlay, transparent
mit Silikon-Rand, grau, 9-Loch

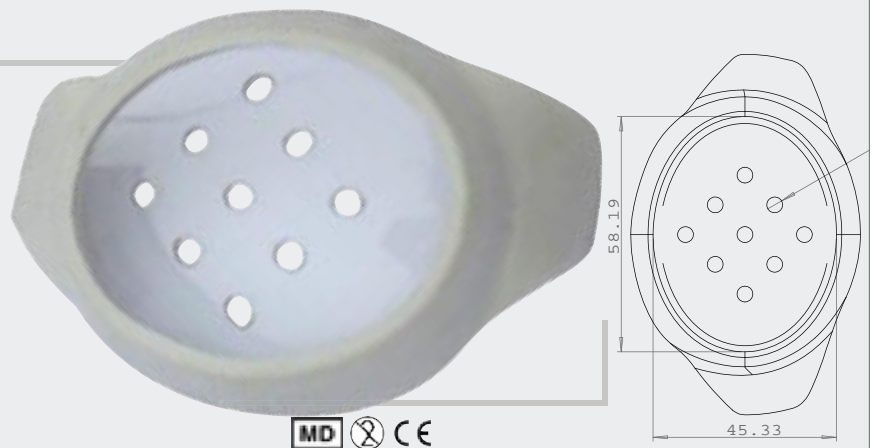

Ref.-Nr.: **AO-607** 80x65 mm



Manipulator Claw Phaco Chopper

Nukleusspalter
gebogene Spitze, Hakenform
runder Griff



Ref.-Nr: **AO-742** Standard-Variante
Länge: 125 mm

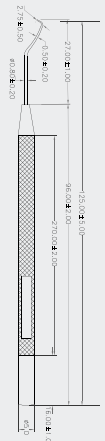

Manipulator Claw Phaco Chopper

Nukleusspalter
gebogene Spitze, Hakenform
runder Griff



Ref.-Nr: **AO-742-Q** Premium-Variante
Länge: 125 mm

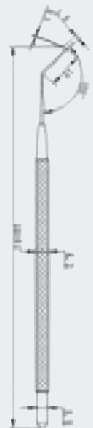

Manipulator Phaco Chopper

Nukleusspalter
gewinkelt
runder Griff



Ref.-Nr: **AO-743** Standard-Variante
Länge: 125 mm



Manipulator Phaco Chopper

Nukleusspalter
gewinkelt
runder Griff



Ref.-Nr: **AO-743-Q** Premium-Variante
Länge: 125 mm



Manipulator MUSHROOM

Irishäckchen und Linsenmanipulator
gewinkelt, runder Griff
Form der Spitze wie ein "Pilz"



Ref.-Nr: **AO-748** Standard-Variante
Länge: 120 mm



Manipulator MUSHROOM

Irishäckchen und Linsenmanipulator
gewinkelt, runder Griff
Form der Spitze wie ein "Pilz"

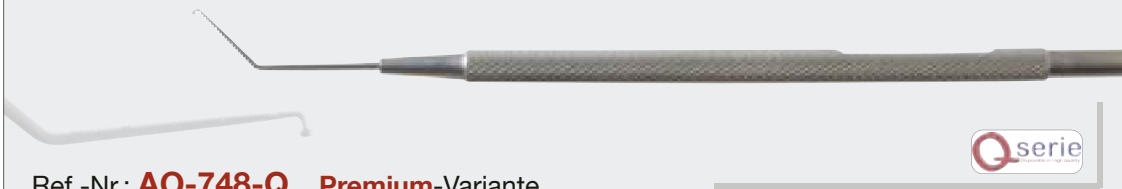

Ref.-Nr: **AO-748-Q** Premium-Variante
Länge: 120 mm

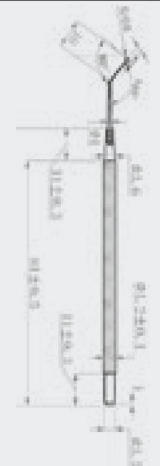

Manipulator Irishaken nach KUGLEN

Irishäckchen und Linsenmanipulator
gewinkelt, runder Griff
Haken nach vorn und hinten



Ref.-Nr: **AO-615** Standard-Variante
Länge: 125 mm



Manipulator Irishaken nach KUGLEN

Irishäckchen und Linsenmanipulator
gewinkelt, runder Griff
Haken nach vorn und hinten



Ref.-Nr: **AO-615-Q** Premium-Variante
Länge: 125 mm



Manipulator Intra-Lasek Flap Separator

runder Griff,
scharfe Spitze



Ref.-Nr: **AO-934** **Standard-Variante**
Länge: 125 mm



Manipulator Intra-Lasek Flap Separator

runder Griff,
scharfe Spitze



Ref.-Nr: **AO-934-Q** **Premium-Variante**
Länge: 125 mm

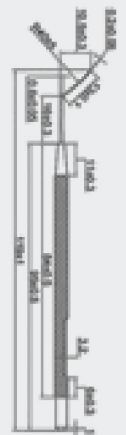

INFORMATION zum Katalog

Q = Premium-Qualität

Einen Teil der ophthalmologischen Metall-Einweginstrumente bieten wir in zwei verschiedenen Qualitäten an. Die Standard- und die Premiumqualität. Die Bestellnummern/Artikelnummern unterscheiden sich durch ein „-Q“ am Ende der Nummer. Artikelnummern in **ROT** mit **-Q** gehören zur **Premium-Qualität**.

Manipulator Schielhaken kurz

runder Griff
5 mm Haken



Ref.-Nr: **AO-810**

Standard-Variante
Länge: 125 mm



Manipulator Schielhaken kurz

runder Griff
5 mm Haken



Ref.-Nr: **AO-810-Q**

Premium-Variante
Länge: 125 mm



Manipulator Schielhaken lang

runder Griff
8 mm Haken



Ref.-Nr: **AO-811**

Standard-Variante
Länge: 125 mm



Manipulator Schielhaken lang

runder Griff
8 mm Haken



Ref.-Nr: **AO-811-Q**

Premium-Variante
Länge: 125 mm



Feiner Wund- & Hauthaken GILLIES

gerade,
eckiger Griff,
runder, spitzer Haken



Ref.-Nr: **ST-8770** Standard-Variante
Länge: 190 mm



Manipulator Linsenhäkchen SINSKEY HOOK

gewinkelt
runder Griff
spitz



Ref.-Nr: **AO-746** Standard-Variante
Länge: 125 mm

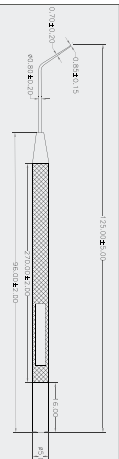

Manipulator Linsenhäkchen SINSKEY HOOK

gewinkelt
runder Griff
spitz



Ref.-Nr: **AO-746-Q** Premium-Variante
Länge: 125 mm



Manipulator KOCH

zur Manipulation des Zellkerns
während der Phako,
gewinkelt, runder Griff



Ref.-Nr: **AO-744-Q** Premium-Variante
Länge: 125 mm

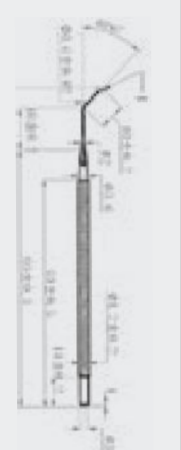

Manipulator Hornhaut-Epithel

runder Griff
zur Manipulation des Epithels bei
Lasek-Verfahren



Ref.-Nr: **AO-951** Standard-Variante
Länge: 125 mm

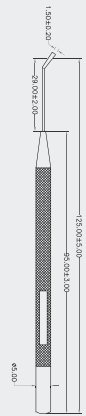

Manipulator Hornhaut-Epithel

runder Griff
zur Manipulation des Epithels
bei Lasek-Verfahren



Ref.-Nr: **AO-951-Q** Premium-Variante
Länge: 115 mm



Manipulator Hornhaut-Epithel

halbrunde Spitzenform
runder Griff
zur Manipulation des Epithels bei
Lasek-Verfahren



Ref.-Nr: **AO-960** Standard-Variante
Länge: 125 mm

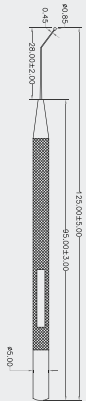

Manipulator Hornhaut-Epithel

halbrunde Spitzenform
runder Griff
zur Manipulation des Epithels bei
Lasek-Verfahren



Ref.-Nr: **AO-960-Q** Premium-Variante
Länge: 125 mm

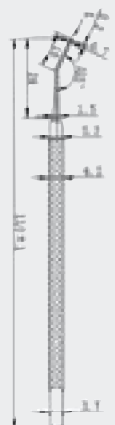

Manipulator HOE Hornhaut-Epithel

rechteckige Spitzenform
runder Griff
zur Manipulation des Epithels bei Lasek-Verfahren

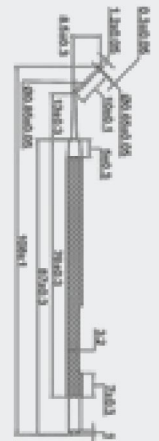

Ref.-Nr: **AO-961-Q** Premium-Variante
Länge: 125 mm

Qserie



Manipulator Lasik Hornhaut

gewinkelt
runder Griff
zwei stumpfe Flossen, 45° abgewinkelt
nach unten zur Markierung der Cornea

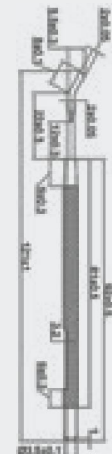
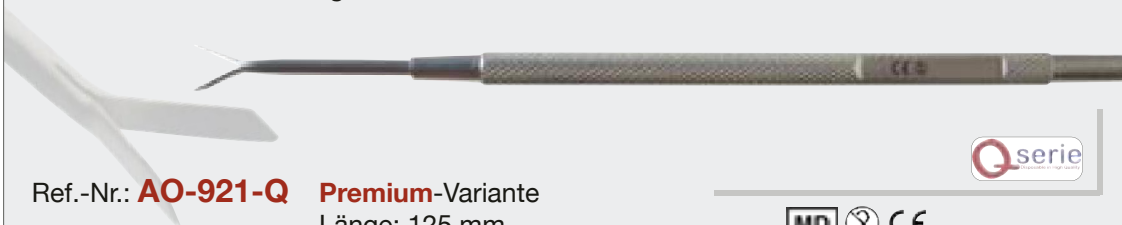

Ref.-Nr: **AO-921-Q** Premium-Variante
Länge: 125 mm

Qserie



INFORMATION zum Katalog

Q = Premium-Qualität

Verschiedene ophthalmologische Metall-Einweginstrumente bieten wir in zwei verschiedenen Qualitäten an. Die Standard- und die Premiumqualität. Die Bestellnummern/Artikelnummern unterscheiden sich durch ein „-Q“ am Ende der Nummer.

Instrumente deren Artikelnummern in **ROTER Schrift** und mit **-Q** enden, gehören zur **Premium-Qualität**.

Manipulator Hornhaut-Heber (Spatel)

gebogen, runder Griff
1 mm abgerundeter Spatel

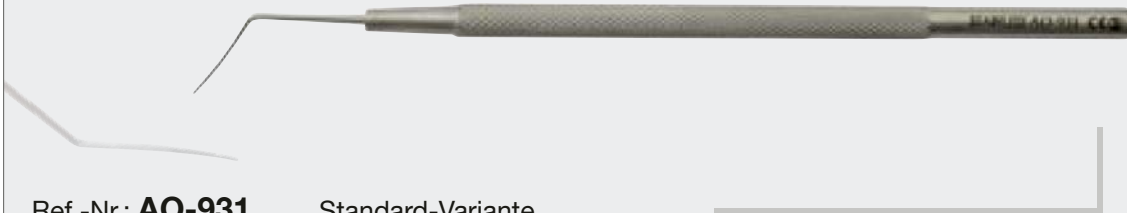

Ref.-Nr: **AO-931** Standard-Variante
Länge: 125 mm



Manipulator Hornhaut-Heber (Spatel)

gebogen, runder Griff
1 mm abgerundeter Spatel



Ref.-Nr: **AO-931-Q** Premium-Variante
Länge: 125 mm



Manipulator Universal Hornhaut-Heber (Spatel)

gebogen, runder Griff
abgeschrägte Spitze



Ref.-Nr: **AO-932** Standard-Variante
Länge: 125 mm



Manipulator Universal Hornhaut-Heber (Spatel)

gebogen, runder Griff
abgeschrägte Spitze



Ref.-Nr: **AO-932-Q** Premium-Variante
Länge: 125 mm



Manipulator Phaco Spatel

gewinkelt, runder Griff

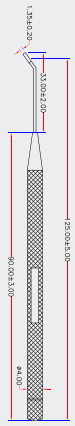

Ref.-Nr: **AO-728**

Standard-Variante
Länge: 125 mm



Manipulator Phakospatel D.D.KOCH

Linsenspatel, leicht gebogen, runder Griff,
feine Spitze mit umlaufender Einkerbung

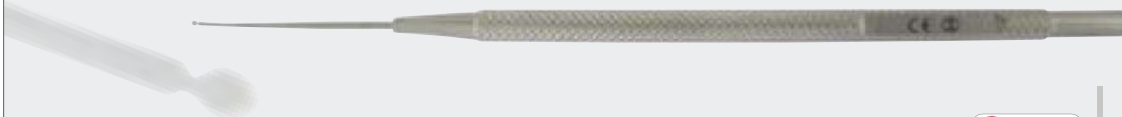

Ref.-Nr: **AO-731-Q**

Premium-Variante
Länge: 125 mm



In unserem Sortiment finden Sie auch hochwertige chirurgische und gynäkologische Einweginstrumente!

Fragen Sie nach unserer Übersicht „Chirurgische Einweginstrumente“.



Lasek Trichter

gewinkelt, runder Griff,
Ø 9 mm

zum Halten von
Alkohol während
der Operation

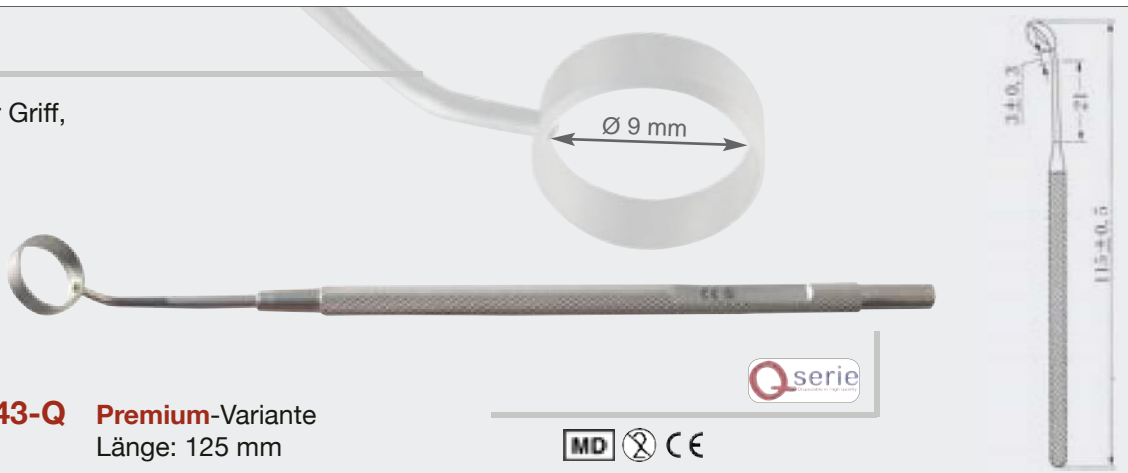

Ref.-Nr.: **AO-943-Q** Premium-Variante
Länge: 125 mm



Lasek Trichter

gewinkelt, runder Griff,
Ø 8 mm

zum Halten von
Alkohol während
der Operation

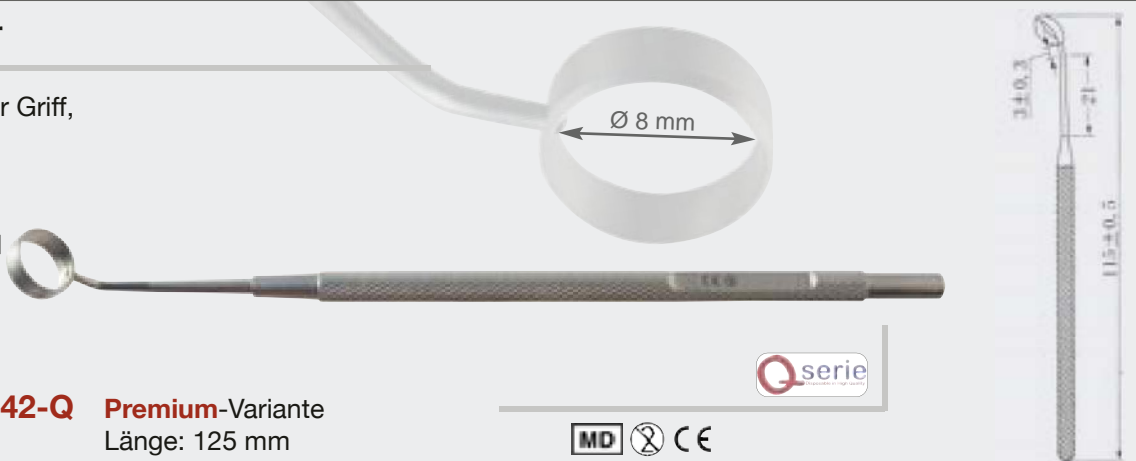

Ref.-Nr.: **AO-942-Q** Premium-Variante
Länge: 125 mm



Lasek Trichter

gewinkelt, runder Griff,
Ø 7 mm

zum Halten von
Alkohol während
der Operation

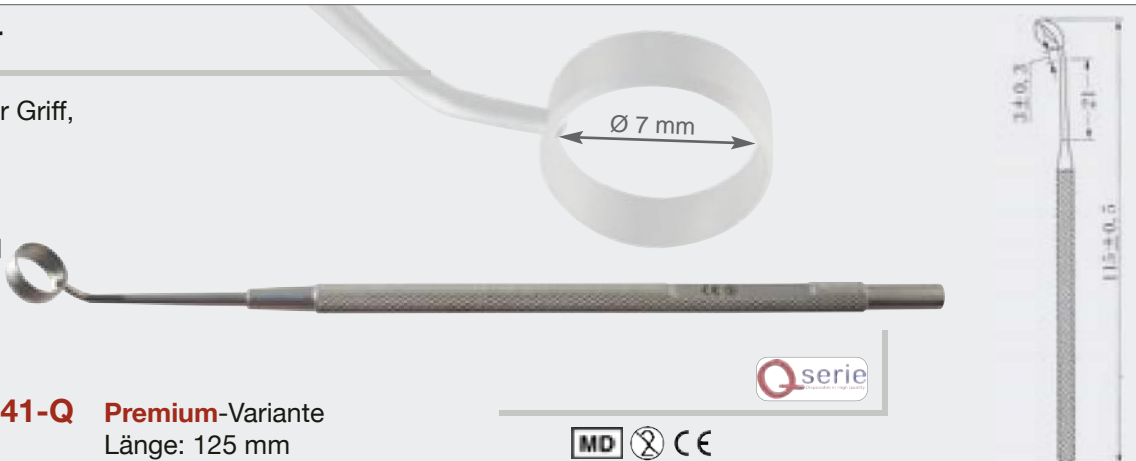

Ref.-Nr.: **AO-941-Q** Premium-Variante
Länge: 125 mm



Scleral Depressor (Neugeborene)

leicht gewinkelt
verdickte Spitze



Ref.-Nr.: **AO-183-Q** Premium-Variante
Länge: 125 mm

Qserie



Scleral Depressor (Neugeborene)

gerade
runder Griff
Spitze in "Hammerform"

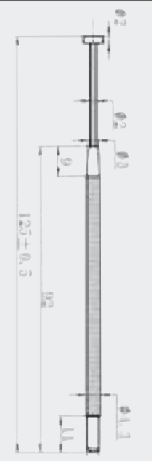

Ref.-Nr.: **AO-184-Q** Premium-Variante
Länge: 125 mm

Qserie



**Wir führen auch chirurgische
und gynäkologische Einweginstrumente
aus Kunststoff und Stahl !**

**Fragen Sie nach unserer Übersicht
„Chirurgische Einweginstrumente“.**



Tränenwegsonde WILDER

„lange“ Spitze
runder Griff, Ø 4 mm

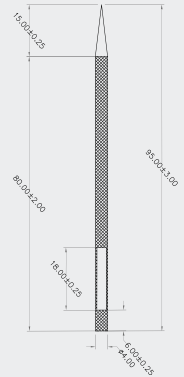

Ref.-Nr: **AO-341** Standard-Variante
Länge: 95 mm



Tränenwegsonde WILDER

„lange“ Spitze
runder Griff, Ø 4 mm



Ref.-Nr: **AO-341-Q** Premium-Variante
Länge: 95 mm



Tränenwegsonde WILDER

„kurze“ Spitze
runder Griff, Ø 4 mm

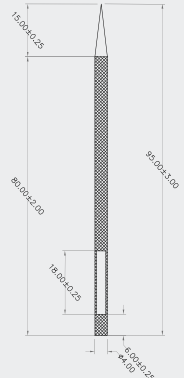

Ref.-Nr: **AO-342** Standard-Variante
Länge: 95 mm



Tränenwegsonde WILDER

„kurze“ Spitze
runder Griff, Ø 4 mm



Ref.-Nr: **AO-342-Q** Premium-Variante
Länge: 95 mm



Tränenwegsonde CASTROVIEJO "2 Enden"

mit „langer“ & „kurzer“ Spitze
runder Griff, Ø 4 mm

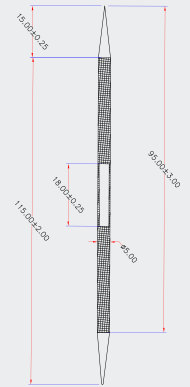

Ref.-Nr: **AO-343**

Standard-Variante
Länge: 115 mm



Tränenwegsonde CASTROVIEJO "2 Enden"

mit „langer“ & „kurzer“ Spitze
runder Griff, Ø 4 mm



Ref.-Nr: **AO-343-Q**

Premium-Variante
Länge: 115 mm



Tränenwegsonde WILDER stumpf

„kurze“ Spitze, leicht abgerundet
runder Griff Ø 4 mm

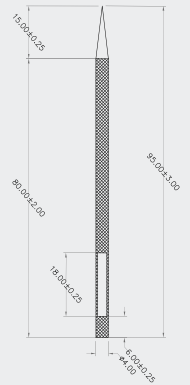

Ref.-Nr: **AO-341-BL**

Standard-Variante
Länge: 95 mm



Chalazionlöffel (scharfer Löffel)

runder Griff, Löffelform rund Ø 1 mm
Ausführung: **klein**



Ref.-Nr.: **AO-391** Standard-Variante
Länge: 135 mm

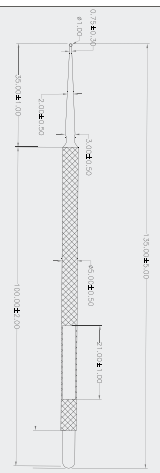

Chalazionlöffel (scharfer Löffel)

runder Griff, Löffelform rund Ø 1 mm
Ausführung: **klein**



Ref.-Nr.: **AO-391-Q** Premium-Variante
Länge: 110 mm



Chalazionlöffel (scharfer Löffel)

runder Griff, Löffelform rund Ø 1,5 mm
Ausführung: **mittel**



Ref.-Nr.: **AO-392** Standard-Variante
Länge: 135 mm

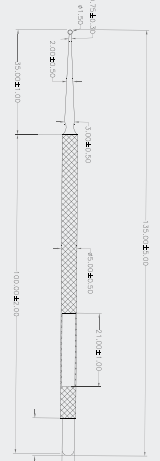

Chalazionlöffel (scharfer Löffel)

runder Griff, Löffelform rund Ø 1,5 mm
Ausführung: **mittel**

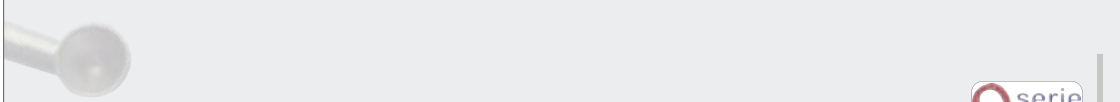

Ref.-Nr.: **AO-392-Q** Premium-Variante
Länge: 110 mm

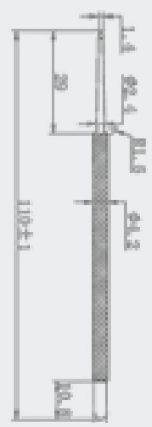

Scharfe Löffel, Chalazionlöffel

Chalazionlöffel (scharfer Löffel)

runder Griff, Löffelform oval 2 mm
Ausführung: **groß**



Ref.-Nr.: **AO-393** Standard-Variante
Länge: 135 mm

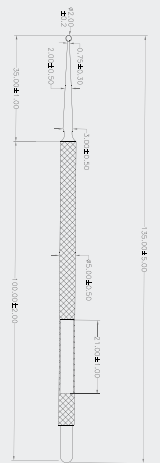

Chalazionlöffel (scharfer Löffel)

runder Griff, Löffelform oval 2 mm
Ausführung: **groß**



Ref.-Nr.: **AO-393-Q** Premium-Variante
Länge: 110 mm



Chalazionlöffel (scharfer Löffel), „2 Enden“

runder Griff
Löffelform rund Ø 1,5 mm & oval 2 mm
Ausführung: **mittel & oval**



Ref.-Nr.: **AO-395-Q** Premium-Variante
Länge: 130 mm



Arterienklemme BABY-MOSQUITO

gebogen, mit Sperre

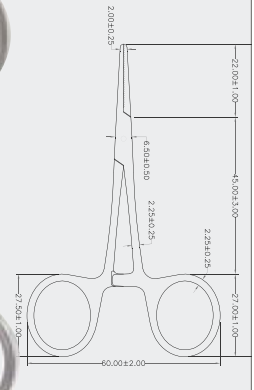

Ref.-Nr.: **ST-8909-C**

Länge: 100 mm



Arterienklemme BABY-MOSQUITO

gerade, mit Sperre

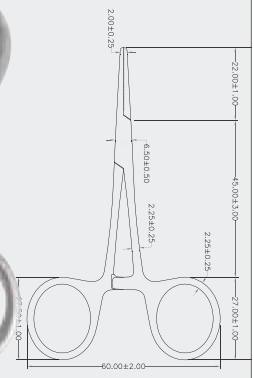

Ref.-Nr.: **ST-8909-S**

Länge: 100 mm



Arterienklemme HALSTED-MOSQUITO

gebogen, mit Sperre

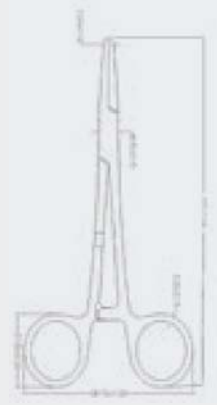

Ref.-Nr.: **ST-8911-C**

Länge: 125 mm



Arterienklemme HALSTED-MOSQUITO

gerade, mit Sperre
Ausführung: feine Spitze

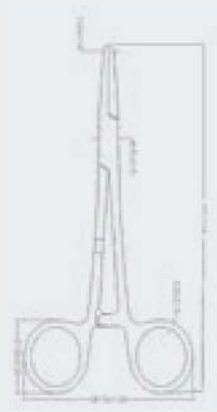
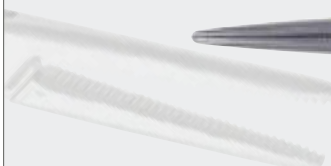

Ref.-Nr.: **ST-8911-S-SM**

Länge: 125 mm

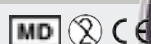

Schwamm-/Tupferklemmen

in den Farben blau und grün lieferbar
mit Sperre



REF **GK-8918-B** blau
GK-8918-G grün
Länge: **18,5 cm**



Tuchklemme BACKHAUS

in den Farben blau und grün lieferbar
mit Sperre

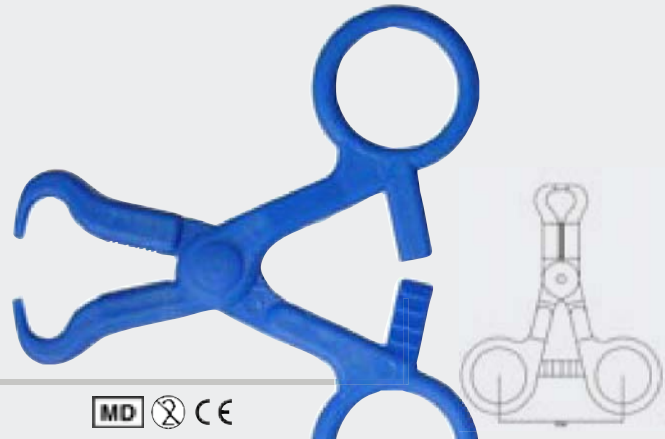

REF **GK-8454-B** blau
Länge: **9 cm**



Kocher-/PEAN-Klemme

in den Farben blau und grün lieferbar
mit Sperre



REF **GK-8348-B** blau
GK-8348-G grün
Länge: **13 cm**



Kocher-/PEAN-Klemme, 14 cm

in den Farben blau und grün lieferbar
verstärker Griffbereich
mit Sperre



REF **GK-8349-B** blau
GK-8349-G grün
Länge: **14 cm**



Universalklemme-Scherenform

mit Sperre

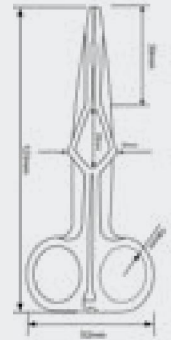
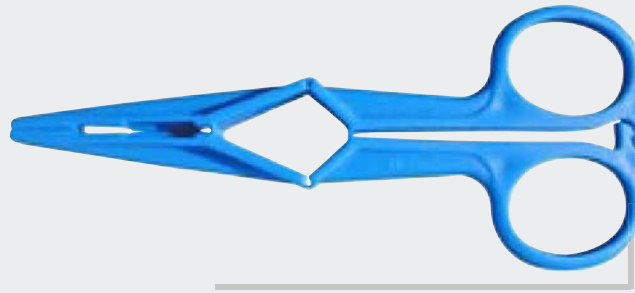

REF **GK-8351-B**

blau

Länge:

12 cm



Universalklemme-KIELER Modell

mit Sperre

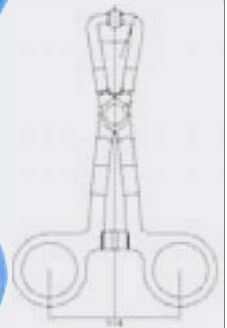

REF **GK-8650-B**

blau

GK-8650-G

grün

Länge:

13 cm



Schlauch-/Dialyseklemme

in den Farben blau und grün lieferbar
mit Sperre

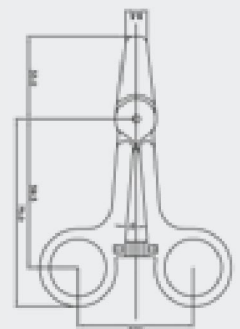

REF **GK-8560-B**

blau

GK-8560-G

grün

Länge:

10,8 cm



Schlauch-/Dialyseklemme

in den Farben blau und grün lieferbar
mit Sperre

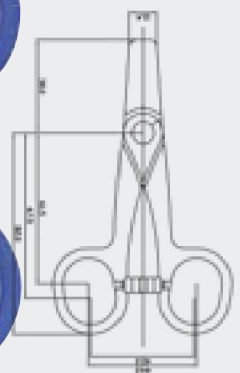

REF **GK-8558-B**

blau

GK-8558-G

grün

Länge:

12 cm



SCILO Vertriebs GmbH

fon +49 (0)2173-1094783 · fax +49 (0)2173-1094785

Raiffeisenstr. 25 · 40764 Langenfeld (Germany)

www.scilo.de · info@scilo.de

